

Powered by



GP 1272 28W ▶ 12V 28W

GP 1272 28W is a general purpose battery up to 5 years in standby service or more than 260 cycles at 100% discharge in cycle service. As with all CSB batteries, all are rechargeable, highly efficient, leak proof and maintenance free.



► Specification

| | |
|--|---|
| Cells Per Unit | 6 |
| Voltage Per Unit | 12 |
| Capacity | 28.7W @ 15min-rate to 1.67V per cell @25°C (77°F) |
| Weight | Approx. 2.1 kg(4.63 lbs) |
| Maximum Discharge Current | 100A/130A(5sec) |
| Internal Resistance | Approx. 21 mΩ |
| Operating Temperature Range | Discharge: -15°C~50°C (5°F~122°F) Charge: -15°C~40°C (5°F~104°F) Storage: -15°C~40°C (5°F~104°F) |
| Nominal Operating Temperature Range | 25°C±3°C (77°F±5°F) |
| Float Charging Voltage | 13.5 to 13.8 VDC/unit Average at 25°C (77°F) |
| Recommended Maximum Charging Current Limit | 2.16A |
| Equalization and Cycle Service | 14.4 to 15.0 VDC/unit Average at 25°C (77°F) |
| Self Discharge | CSB Batteries can be stored for more than 6 months at 25°C (77°F). Please charge batteries before using. For higher temperatures the time interval will be shorter. |
| Terminal | F1/F2-Faston Tab187/250 |
| Container Material | ABS(UL 94-HB/File E50263)*Flammability resistance of (UL 94-V0/File E88637) can be available upon request. |



CSB-manufactured **VRLA** (Absorbent **G**lass **M**at type) batteries are UL-recognized components under UL1989.

CSB is also certified by ISO 9001 and ISO 14001.

| ► Dimensions : | Overall Height (H) | Container height (h) | Length (L) | Width (W) |
|-----------------|----------------------|----------------------|-------------------|--------------------|
| Unit: mm (inch) | 98.6±1.5 (3.88±0.06) | 94.3±1 (3.71±0.04) | 151±2 (5.94±0.08) | 64.8±1 (2.55±0.04) |

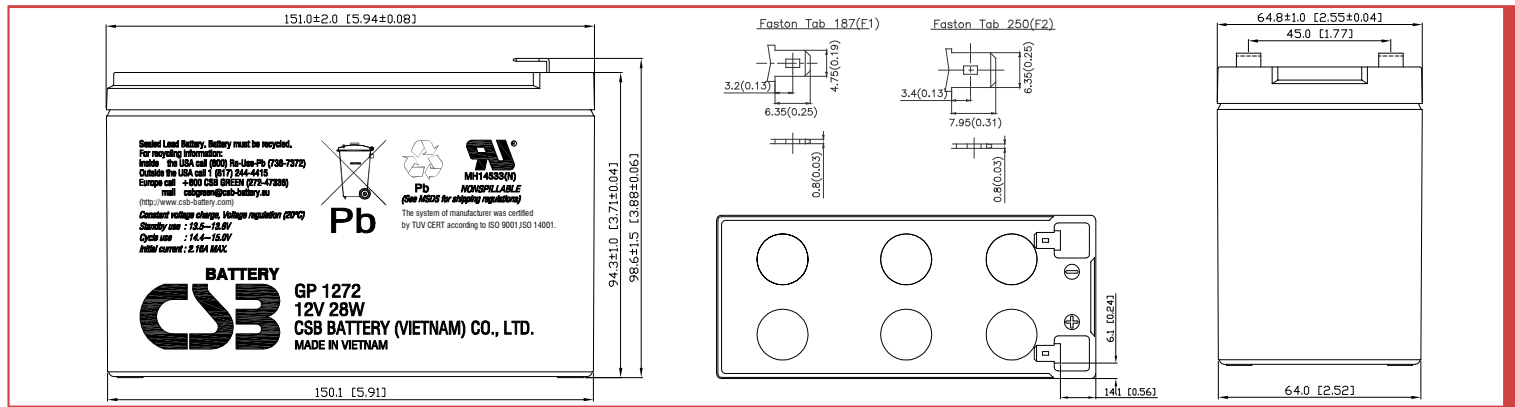

Constant Current Discharge Characteristics Unit:A (25°C, 77°F)

| F.V/Time | 2MIN | 4MIN | 5MIN | 6MIN | 8MIN | 10MIN | 15MIN | 20MIN | 30MIN | 60MIN | 90MIN |
|----------|------|------|------|------|------|-------|-------|-------|-------|-------|-------|
| 1.60V | 58.3 | 39.7 | 34.1 | 29.9 | 24.1 | 20.8 | 15.0 | 12.0 | 8.73 | 4.98 | 3.52 |
| 1.67V | 52.8 | 36.8 | 31.9 | 28.3 | 23.5 | 20.4 | 14.9 | 11.9 | 8.65 | 4.95 | 3.50 |
| 1.70V | 50.2 | 35.4 | 30.8 | 27.5 | 23.0 | 20.1 | 14.7 | 11.8 | 8.61 | 4.92 | 3.48 |
| 1.75V | 45.7 | 32.6 | 28.7 | 26.0 | 22.1 | 19.5 | 14.4 | 11.6 | 8.53 | 4.89 | 3.46 |
| 1.80V | 41.1 | 29.8 | 26.6 | 24.4 | 20.7 | 18.5 | 13.9 | 11.2 | 8.26 | 4.81 | 3.41 |
| 1.85V | 36.5 | 27.3 | 24.5 | 22.7 | 19.3 | 17.1 | 13.0 | 10.6 | 7.92 | 4.63 | 3.31 |

Constant Power Discharge Characteristics Unit:W (25°C, 77°F)

| F.V/Time | 2MIN | 4MIN | 5MIN | 6MIN | 8MIN | 10MIN | 15MIN | 20MIN | 30MIN | 60MIN | 90MIN |
|----------|------|------|------|------|------|-------|-------|-------|-------|-------|-------|
| 1.60V | 595 | 410 | 356 | 318 | 268 | 232 | 174 | 139 | 101 | 58.5 | 41.8 |
| 1.67V | 552 | 387 | 339 | 305 | 262 | 229 | 172 | 138 | 100 | 58.1 | 41.6 |
| 1.70V | 532 | 373 | 329 | 298 | 260 | 226 | 171 | 137 | 99.3 | 57.8 | 41.4 |
| 1.75V | 499 | 350 | 312 | 286 | 249 | 220 | 168 | 135 | 98.8 | 57.4 | 41.1 |
| 1.80V | 464 | 327 | 294 | 272 | 237 | 212 | 162 | 132 | 96.8 | 56.4 | 40.6 |
| 1.85V | 425 | 305 | 275 | 256 | 220 | 197 | 152 | 125 | 93.1 | 54.9 | 39.6 |

Ratings presented herein are subject to revision without notice. Please refer to www.csb-battery.com to confirm the latest version.

Trickle (or Float) Service Life

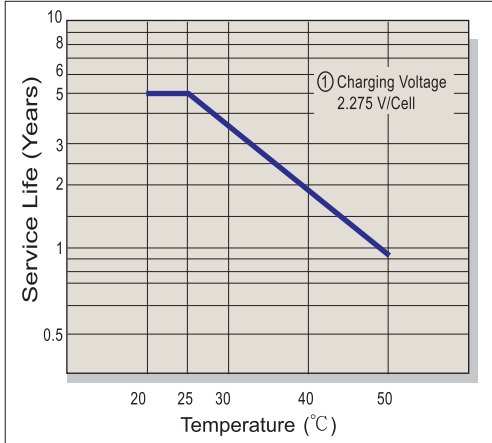

Capacity Retention Characteristic

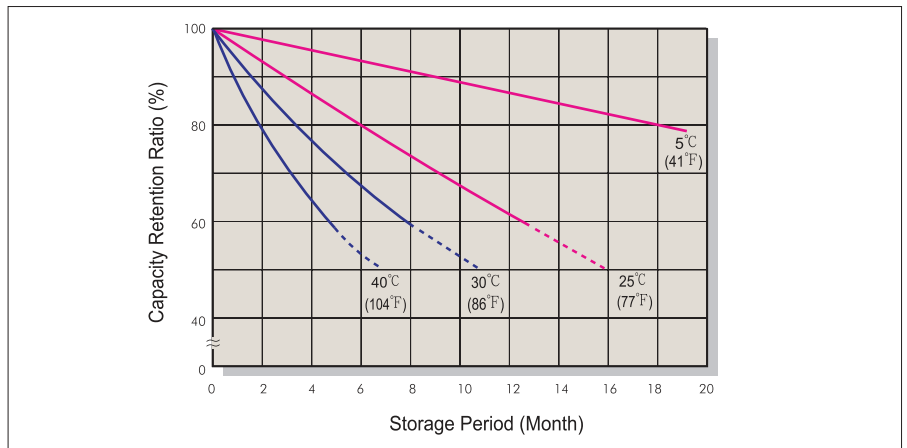

Battery Voltage and Charge Time for Standby Use

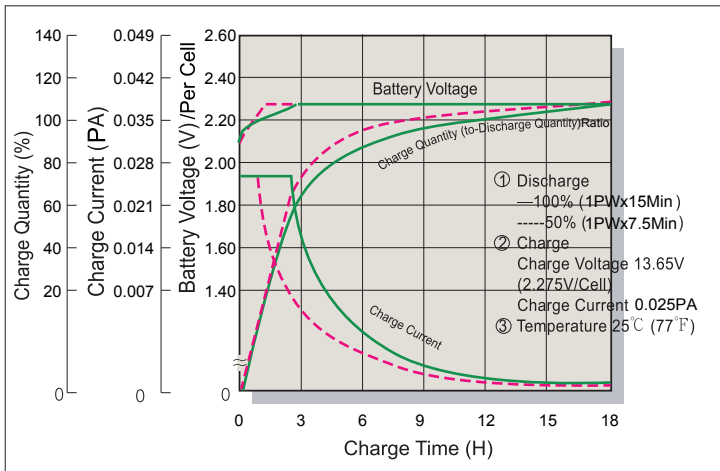

Cycle Service Life

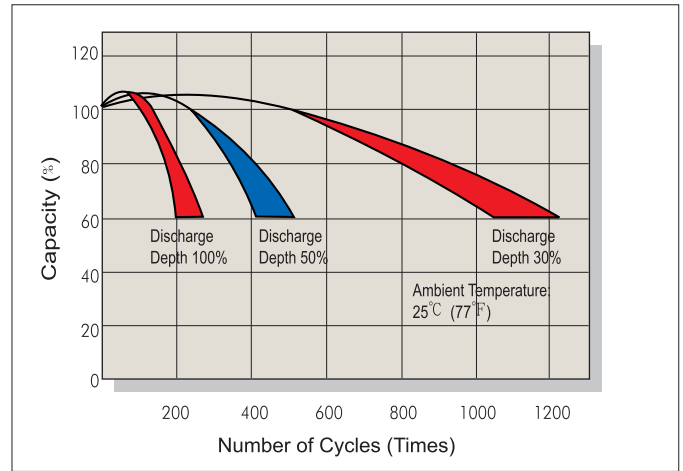

Battery Voltage and Charge Time for Cycle Use

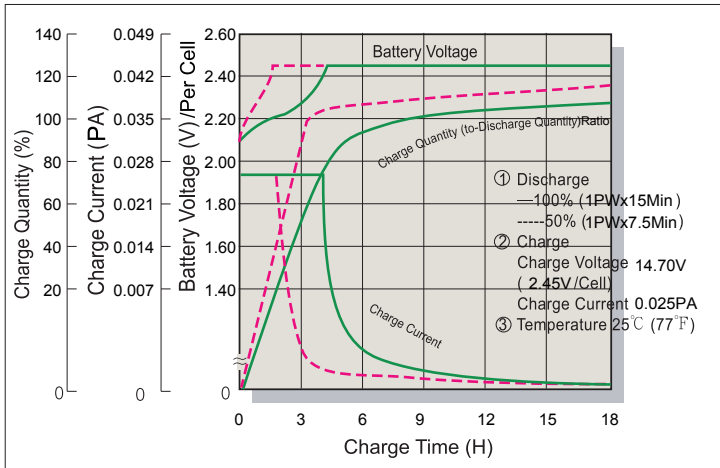

Terminal Voltage (V) and Discharge Time

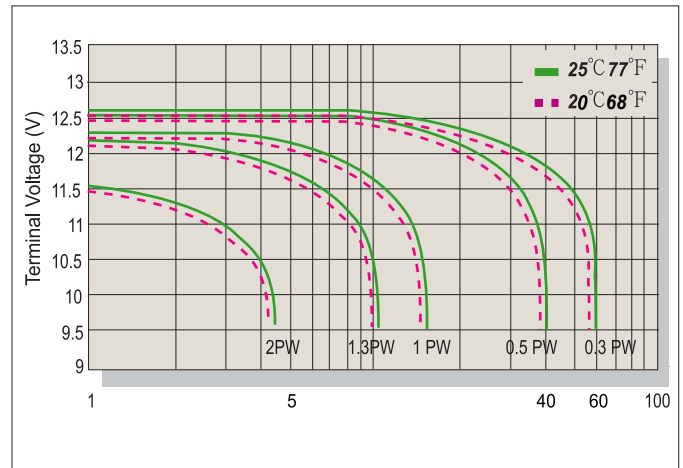

Charging Procedures

| Application | Charge Voltage(V/Cell) | | | Max.Charge Current |
|-------------|------------------------|-----------|-----------------|--------------------|
| | Temperature | Set Point | Allowable Range | |
| Cycle Use | 25°C(77°F) | 2.45 | 2.40~2.50 | 0.1PA |
| Standby | 25°C(77°F) | 2.275 | 2.25~2.30 | |

Discharge Current VS. Discharge Voltage

| Final Discharge Voltage V/Cell | 1.75 | 1.70 | 1.60 | 1.30 |
|--------------------------------|----------|----------------|----------------|----------|
| Discharge Power(W) | 0.1P>(W) | 0.1P≤(W)<0.25P | 0.25P≤(W)<1.0P | (W)≥1.0P |

Sales Office URL: WWW.CSB-BATTERY.COM

GLOBAL HQ
CSB BATTERY CO., LTD. (TAIWAN)
 Tel : +886-2-2880-5600
 Fax : +886-2-2888-3300
 mail : service@csb-battery.com.tw

BEIJING OFFICE. (CHINA)
CSB BATTERY TECHNOLOGIES (BEIJING) CO., LTD.
 Tel : +86-10-5820-5336/5338
 Fax : +86-10-58203053
 mail : chinasl@csb-battery.com

AMERICA HQ
CSB BATTERY TECHNOLOGIES INC. (U.S.A)
 Tel : +1-817-244-7777/1-(800)3-CSB-USA(272872)
 Fax : +1-817-244-4445
 mail : csb@csb-battery.com

SHANGHAI OFFICE. (CHINA)
CSB BATTERY LOGISTIC (SHANGHAI) CO., LTD.
 Tel : +86-21-5046-1622/5046-0833
 Fax : +86-21-5064-1046
 mail : chinasl@csb-battery.com

EUROPE HQ
CSB Battery Europe BV.
 Tel : +31(0)-180-418-140
 Fax : +31(0)-180-418-327
 mail : eurosales@csb-battery.eu

SHENZHEN OFFICE.(CHINA)
CSB BATTERY LOGISTIC (SHANGHAI) CO., LTD.
 Tel : +86-755-8831-6488/6396/6356
 Fax : +86-755-8831-6548
 mail : she@csb-battery.com.cn