



**Low Voltage System  
Out-door Cabinet**  
(Cabinet OD1310-LV)

**1** External Power Cable -

**2** External Power Cable +

**3** Fan Power Cable -/+

**4** External Communication Cable

# Pylontech Out-door Cabinet Cable Connection

## Cables connection of **lower layer 3** batteries

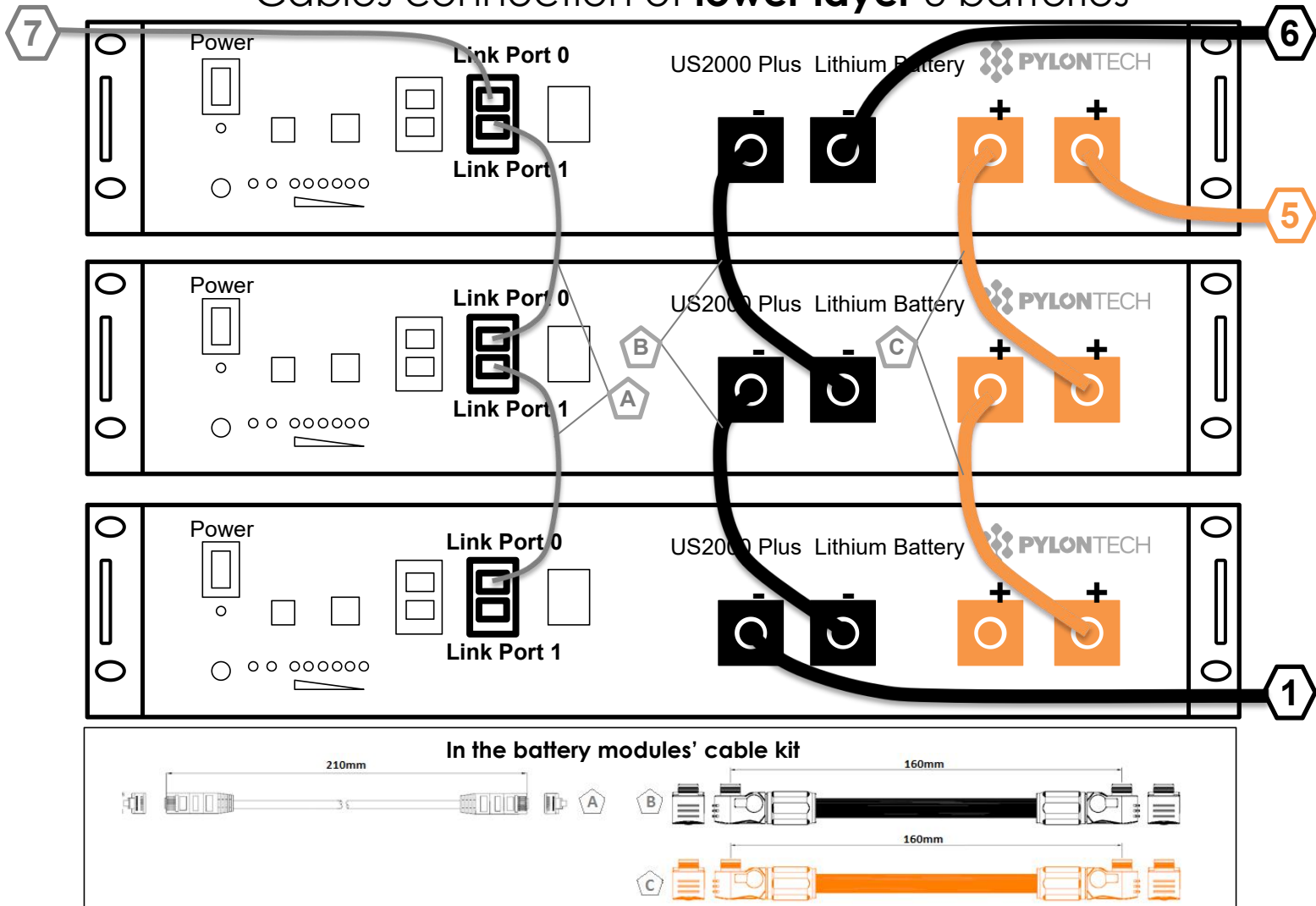

## Cables connection of **upper layer 3** batteries

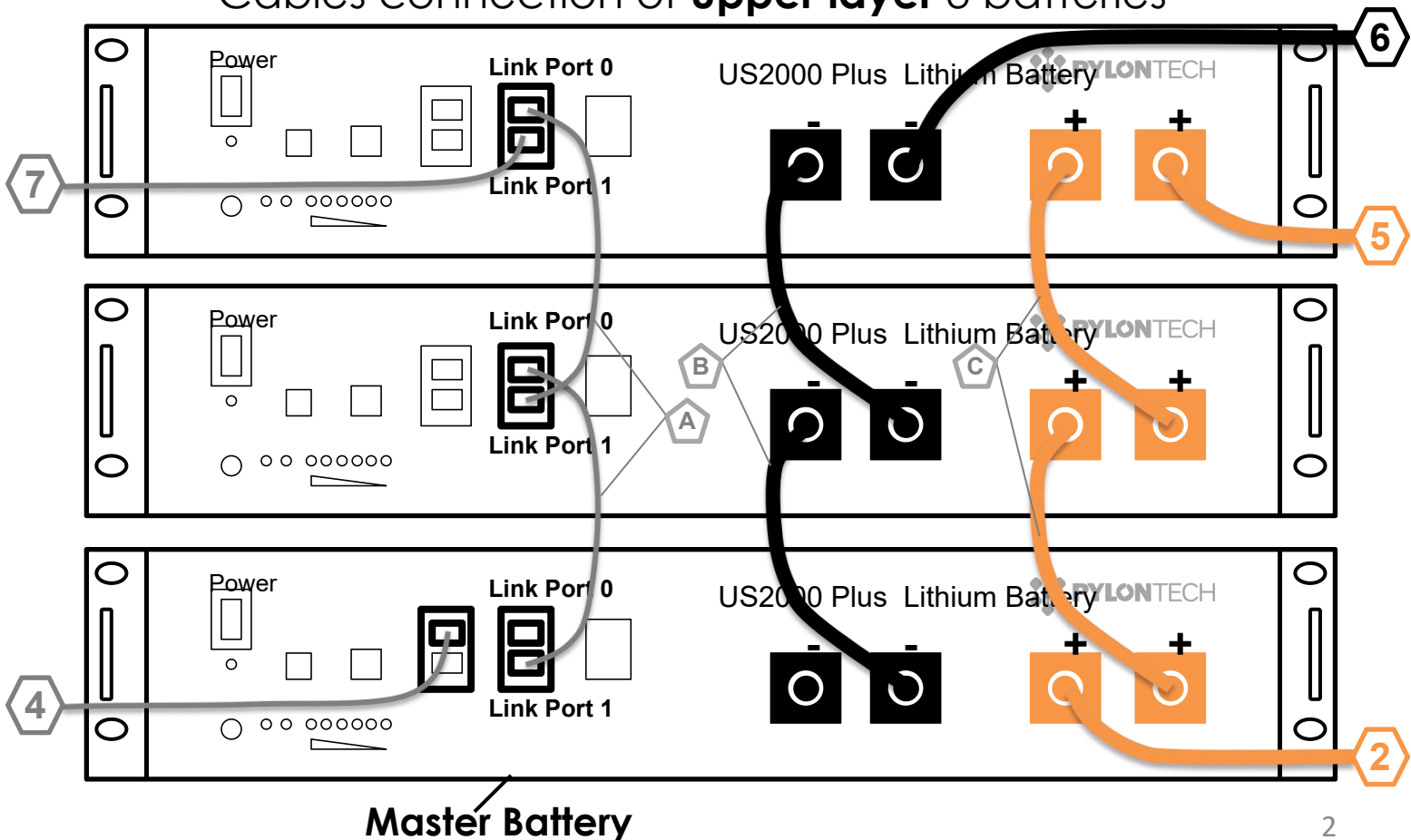

Unpack the corrugated carton.

And lift the cabinet from the carton.

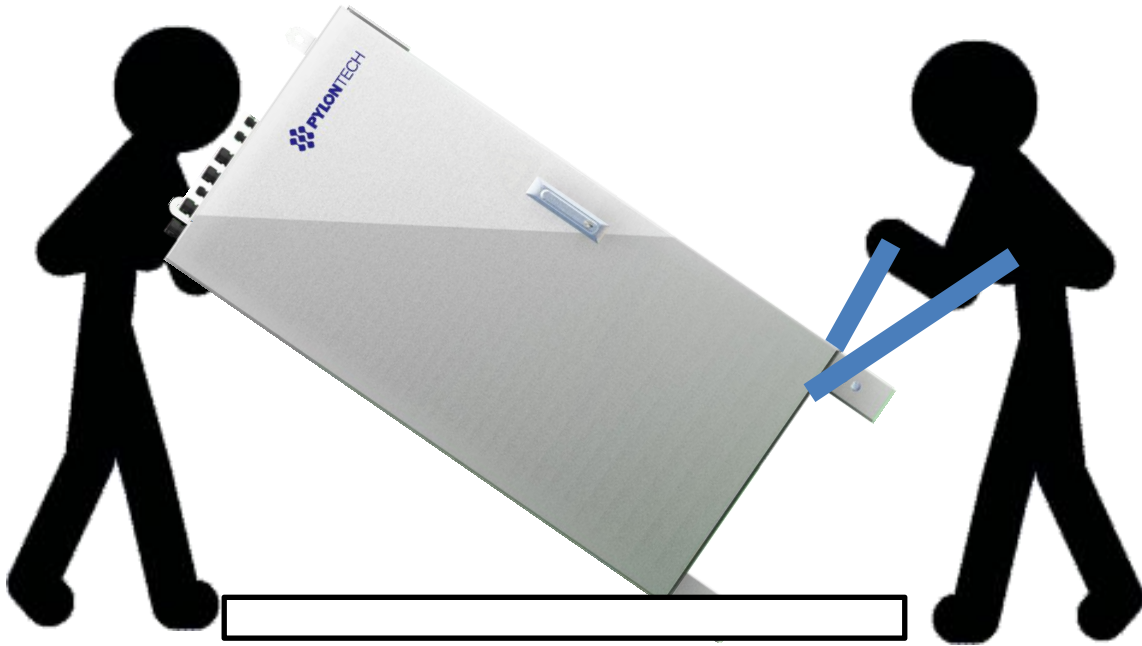
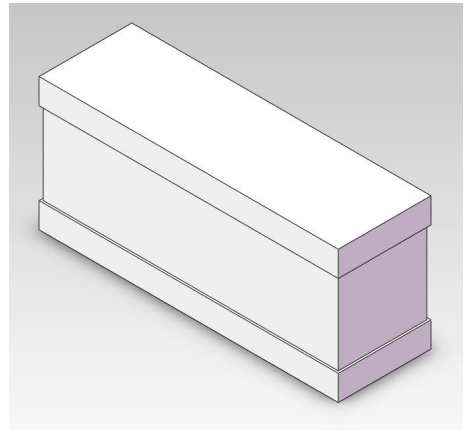

Move the cabinet to the basement.

Please use the attached 2 wide nylon belts to handling cabinet.



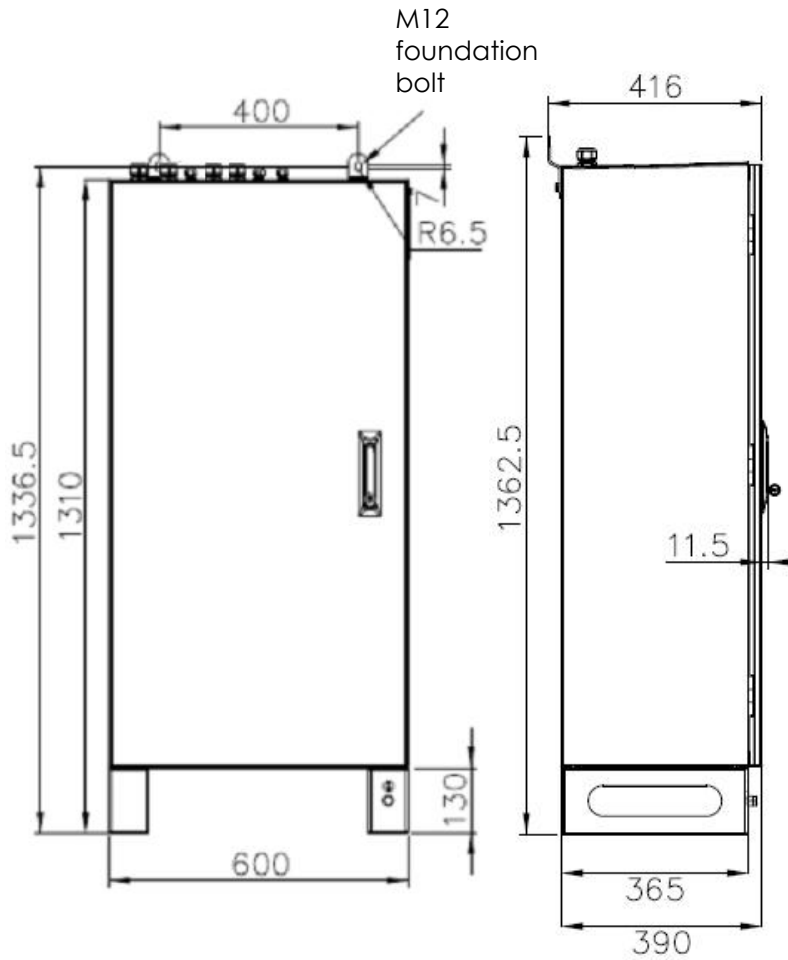

**Fix with the hangers (recommend)**

Install the 2 hangers to back face of outside.  
Dismantel these 2 screws to pull the cables out.

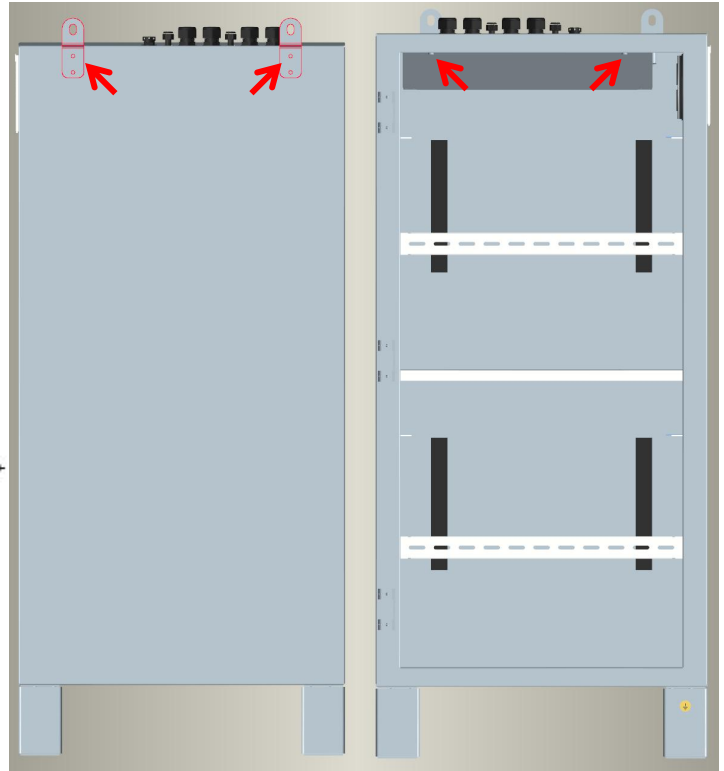

Or fix the cabinet with the cabinet feet.

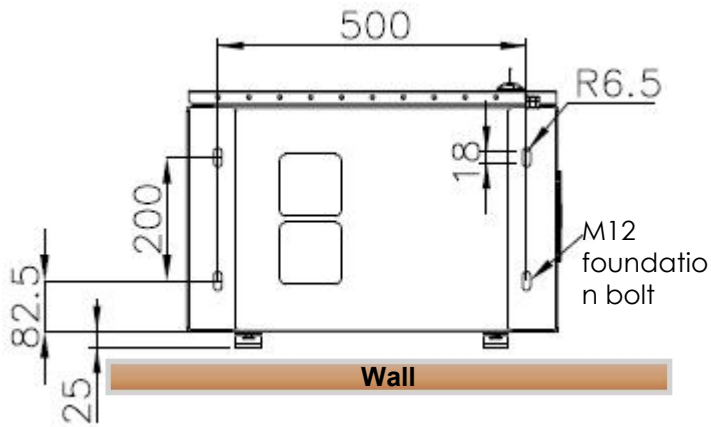

Connect the grounding cable from basement.

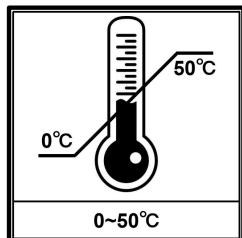
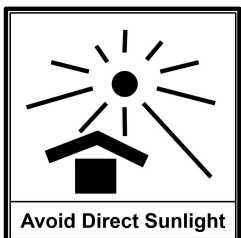
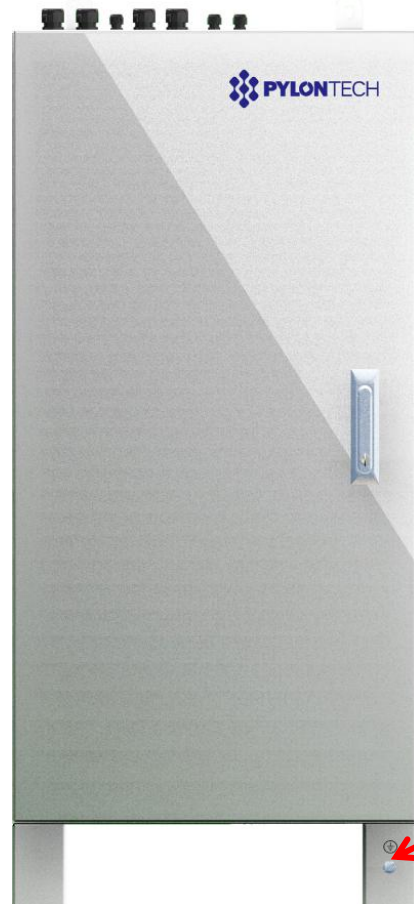

Take away the 4 shield sleeves on the rails. Put 3 batteries on the under layer. And lock the blade bolt. Align the calibration and the battery's hole.



Lock the 6 dowels for these 3 batteries.



- Connect the cables of **lower layer** 3 batteries. Please see < Cabinet OD Cable Connection >.

Put the separate board on the 4 stop blocks.



Install 3 batteries on the upper layer just like under layer. And lock the blade bolt.

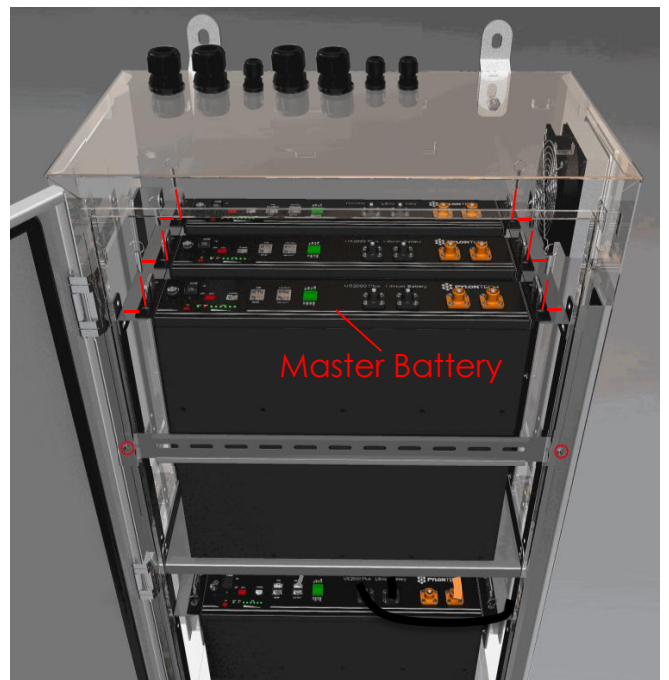

- Connect the cables of **lower layer** 3 batteries. Please see < Cabinet OD Cable Connection >.

- Connect the     cable terminals to the inverter.

- Turn on each battery's power switch.
- Press Master Battery's soft start button. Please see the product menu (capital 4.2 B).



**PYLONTECH**

Distributed by:

**YHI POWER PTY LTD**

20-22 Venture Way Braeside VIC 3195

**T** 1300 722 028 | **F** 1300 722 328

**E** [sales@yhipower.com.au](mailto:sales@yhipower.com.au)

**W** [www.yhipower.com.au](http://www.yhipower.com.au)