

Overview

Vision Technology provides safe LiFePO₄ battery solutions for UPS and Energy storage system. This battery system serves for UPS and Energy storage system with perfect compatibility and safe long cycle life.

Features

- Internal cell balancing ,Passive equalization , the maximum equalization current up to 200mA;
- High-precision cell voltage and temperature acquisition:±3mv,±1C;
- Automatic circulation control and automatic, easy to realize parallel machine use;
- Fire extinguision device in the module, 7*24H all-weather fire;
- IBB integrated bus design in the module realizes the cell string without screws and cables;
- Full state management, 100% real-time cell management and functional device control;
- High-precision leakage detection to prevent insulation failure and ensure system reliability.

Module Preview

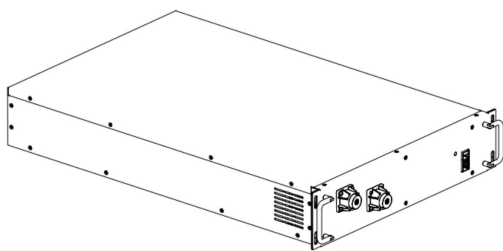

Module 51.2V50Ah

Performance Data

Time(min)	5	10	15	20	30
Constant Power(kw)	210	118	80	60	41
Constant Current(A)	400	240	160	120	80

Rack Specification

Voltage Range(V)	448~552
Cell	3.2V50Ah
Series & Parallels	160S1P
Rated Voltage(V)	512
Rated Capacity(Ah)	50
Rated Energy(KWh)	25.6
Recommended Charging Current(A)	10~25
Discharge cut-off Voltage(V)	448
Charge Voltage(V)	544 ~ 552
Cycle Life(@25°C, 0.5C/0.5C,100%DOD)	≥2000
Short-circuit Current(< 10ms)	Approx.8500
System Dimension(W* D* H)	(600*1000*2000) mm
Total Weight(Kg)	Approx. 600
Internal Resistance Fully Charged@ 25°C	≤60mOhms
Thermal Management	Air Cooling
Charge Temperature	0 ~ 50 °C
Discharge Temperature	-20 ~ 65°C
Operating Humidity	< 95%R.H.
Communication	CAN/RS485/TCP
System Parallels	≤15(GBMS)
Dry Contact	3 outputs, 1 input
Design life	15 years

Module size

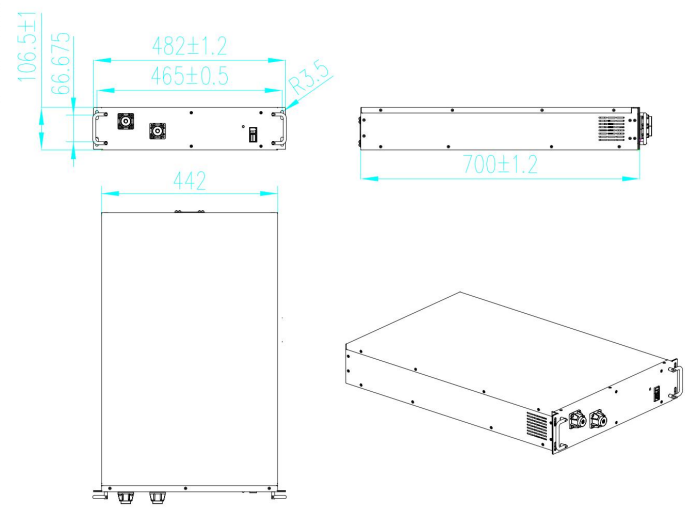

Rack

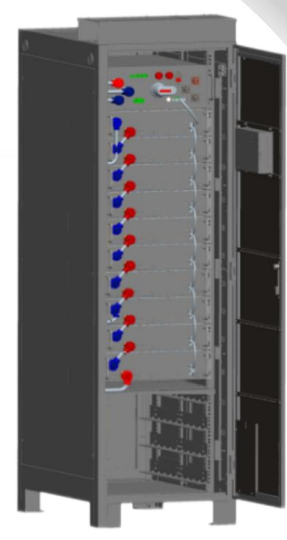

Rack TPH200(S)

TPH200S-with LCD TPH200-without LCD

Characteristics Curve

Discharge Performance at 25 °C
(n is the number of modules)

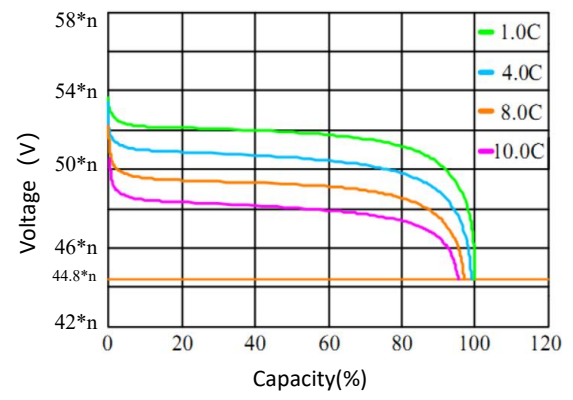

Charge and Discharge at 25 °C, 0.5C
(n is the number of modules)

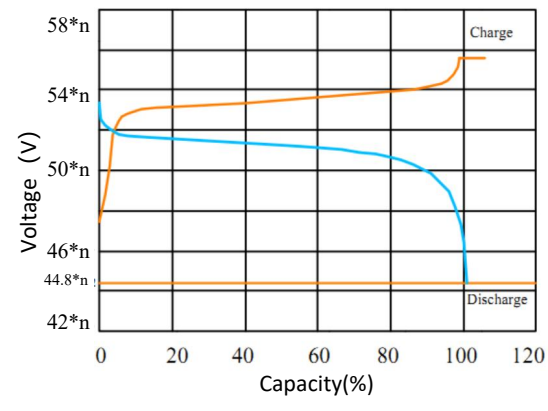

Temperature effects on capacity at 0.5C

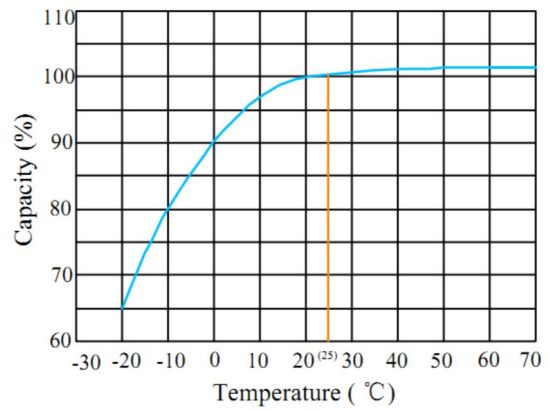

Cycle life with DOD at 25°C
10C discharge and 1C charge

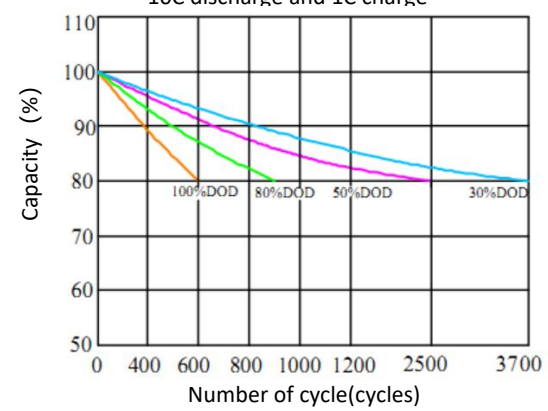

SHENZHEN CENTER POWER TECH. CO., LTD.

Copyright ©SHENZHEN CENTER POWER TECH. CO., LTD.2022. All rights reserved.
Without the written consent of SHENZHEN CENTER POWER TECH. CO., LTD., no unit or individual is allowed to extract or copy part or all of the contents of this manual without authorization, and it is not allowed to disseminate it in any form.

Disclaimer: This manual is as comprehensive and detailed as possible on the basis of existing materials, but the company reserves the final right to data, parameters and other information. No further notice!
The right of final interpretation belongs to SHENZHEN CENTER POWER TECH. CO., LTD..

Call +86-755 6685 1118
Fax +86-755 6685 0678
E-Mail sales@vision-batt.com
Website www.vision-batt.com



WeChat official account